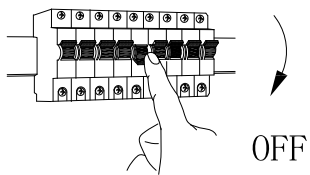
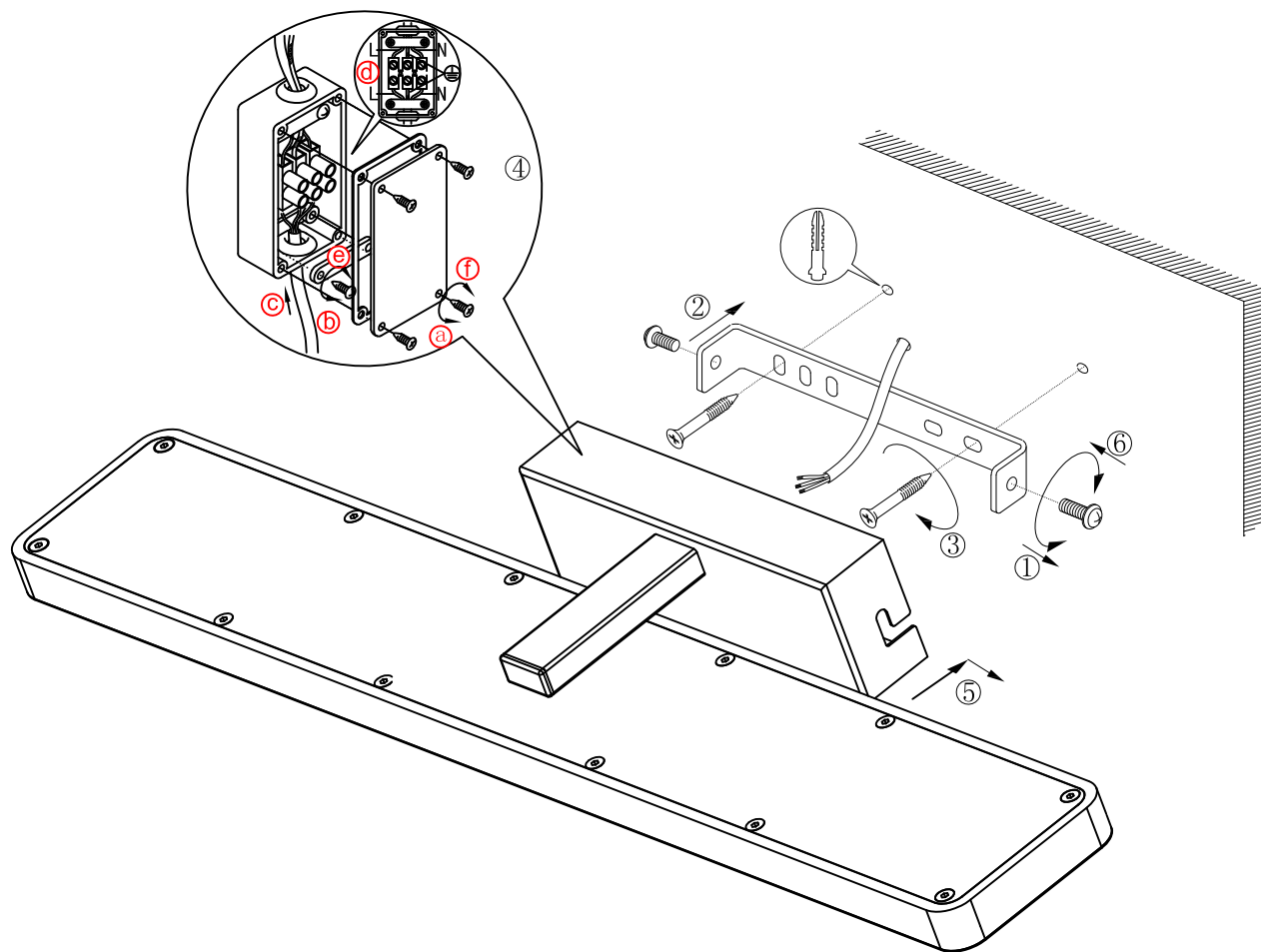
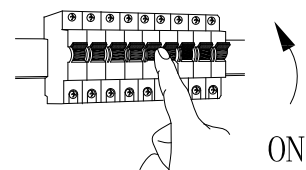

**A****B****C**

BLA96937

www.eglo.com